

SPS Series

13.3kW Programmable DC Power Supply



FEATURES

- 6U Rack Height
- Wide range available, up to 800V & 1200A
- GPIB/SCPI, RS232, Ethernet & USB Interface available
- Closed case calibration
- LED Display module
- Programmable protection modes
- TTL on-off control
- Master/slave capability, up to 31 channels available
- Modifications possible

ENVIRONMENTAL

Storage Temp:	-40°C to +70°C
Operating Temp:	0°C to +50°C
Humidity:	0 to 80% RH Non-condensing

SAFETY / EMC

EN60950
CE marked in accordance with the
Low Voltage Directive (LVD)

UL approved to UL60950

ELECTRICAL SPECIFICATIONS

INPUT

AC INPUT	208/240VAC 3-phase
(Auto switching)	380/415VAC 3-phase
	440/480VAC 3-phase

Frequency	50 - 60Hz
-----------	-----------

OUTPUT

Line Regulation	±0.05% - CV or CC mode
Load Regulation	±0.05% - CV or CC mode
Transient Response (1)	10mS
Stability (2)	±0.01% +10mV
Temp. Coefficient (3)	0.04% / °C of max. output I
Output Isolation	2500VDC

Built in Interface	RS 232
--------------------	--------

NOTES:

1. 30% load change within 2% of nominal voltage
2. Under constant load, line & temp. over an 8 hour interval after a 30 min. warm up period
3. After 30 min. warm up period

Specifications subject to change without notice

Safety Power Group Ltd

9, Farnborough Business Centre, Eelmoor Road, Farnborough, Hampshire. GU14 7QN

Tel: +44 (0) 1252 515565

Fax: +44 (0) 1252 546021

e-mail: sales@safety-power.com

web: www.safety-power.com

AVAILABLE MODELS

MODEL No.	OUTPUT VOLTAGE	OUTPUT CURRENT
SPS10-1200	0 - 10VDC	0 - 1200ADC
SPS16-800	0 - 16VDC	0 - 800ADC
SPS32-400	0 - 32VDC	0 - 400ADC
SPS60-221	0 - 60VDC	0 - 221ADC
SPS80-166	0 - 80VDC	0 - 166ADC
SPS125-106	0 - 125VDC	0 - 106ADC
SPS200-66	0 - 200VDC	0 - 66ADC
SPS250-53	0 - 250VDC	0 - 53ADC
SPS375-35	0 - 375VDC	0 - 35ADC
SPS500-26	0 - 500VDC	0 - 26ADC
SPS600-21	0 - 600VDC	0 - 21ADC
SPS800-16	0 - 800VDC	0 - 16ADC

ORDERING INFORMATION

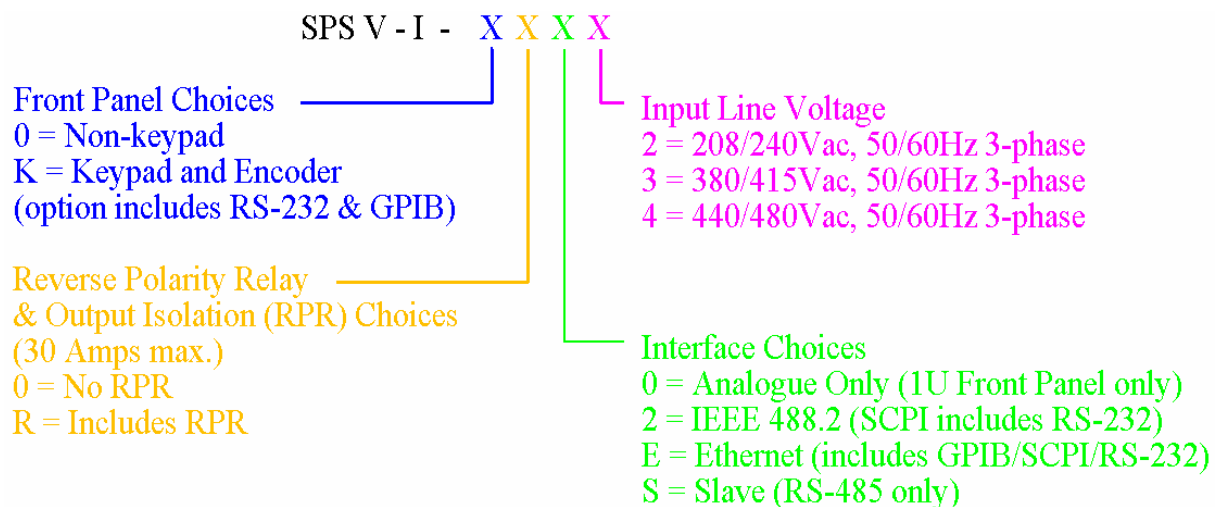

Specifications subject to change without notice

Safety Power Group Ltd

9, Farnborough Business Centre, Eelmoor Road, Farnborough, Hampshire. GU14 7QN

Tel: +44 (0) 1252 515565 Fax: +44 (0) 1252 546021

e-mail: sales@safety-power.com web: www.safety-power.com